

CHICAGO  **ELECTRIC**[®]
POWER TOOLS

12V LITHIUM-ION MULTIFUNCTION TOOL

Model 67707

SET UP AND OPERATING INSTRUCTIONS



Visit our website at: <http://www.harborfreight.com>



**Read this material before using this product.
Failure to do so can result in serious injury.
SAVE THIS MANUAL.**

Copyright© 2010 by Harbor Freight Tools®. All rights reserved. No portion of this manual or any artwork contained herein may be reproduced in any shape or form without the express written consent of Harbor Freight Tools. Diagrams within this manual may not be drawn proportionally. Due to continuing improvements, actual product may differ slightly from the product described herein. Tools required for assembly and service may not be included.

For technical questions or replacement parts, please call 1-800-444-3353.

SAVE THIS MANUAL

Keep this manual for the safety warnings and precautions, assembly, operating, inspection, maintenance and cleaning procedures. Write the product's serial number in the back of the manual near the assembly diagram (or month and year of purchase if product has no number). Keep this manual and the receipt in a safe and dry place for future reference.

IMPORTANT SAFETY INFORMATION

In this manual, on the labeling, and all other information provided with this product:



This is the safety alert symbol. It is used to alert you to potential personal injury hazards. Obey all safety messages that follow this symbol to avoid possible injury or death.

DANGER

DANGER indicates a hazardous situation which, if not avoided, will result in death or serious injury.

WARNING

WARNING indicates a hazardous situation which, if not avoided, could result in death or serious injury.

CAUTION

CAUTION, used with the safety alert symbol, indicates a hazardous situation which, if not avoided, could result in minor or moderate injury.

NOTICE

NOTICE is used to address practices not related to personal injury.

CAUTION

CAUTION, without the safety alert symbol, is used to address practices not related to personal injury.

General Power Tool Safety Warnings



WARNING Read all safety warnings and instructions. *Failure to follow the warnings and instructions may result in electric shock, fire and/or serious injury.*

Save all warnings and instructions for future reference.

The term "power tool" in the warnings refers to your battery-operated (cordless) Multifunction Tool.

1. **Work area safety**
 - a. **Keep work area clean and well lit.**
Cluttered or dark areas invite accidents.
 - b. **Do not operate power tools in explosive atmospheres, such as in the presence of flammable liquids, gases or dust.** *Power tools create sparks which may ignite the dust or fumes.*
 - c. **Keep children and bystanders away while operating a power tool.**
Distractions can cause you to lose control.
2. **Electrical safety**

Do not expose power tools to rain or wet conditions. *Water entering a power tool will increase the risk of electric shock.*
3. **Personal safety**
 - a. **Stay alert, watch what you are doing and use common sense when operating a power tool. Do not use**

- a power tool while you are tired or under the influence of drugs, alcohol or medication. *A moment of inattention while operating power tools may result in serious personal injury.*
- b. **Use personal protective equipment. Always wear eye protection.** *Safety equipment such as a dust mask, non-skid safety shoes, a hard hat, or hearing protection used for appropriate conditions will reduce personal injuries.*
 - c. **Prevent unintentional starting. Ensure the Power Switch is in the off-position before connecting to power source and/or battery pack, picking up or carrying the tool.** *Carrying power tools with your finger on the power switch invites accidents.*
 - d. **Remove any adjusting key or wrench before turning the power tool on.** *A wrench or a key left attached to any part of the power tool may result in personal injury.*
 - e. **Do not overreach. Keep proper footing and balance at all times.** *This enables better control of the power tool in unexpected situations.*
 - f. **Dress properly. Do not wear loose clothing or jewelry. Keep your hair, clothing and gloves away from moving parts.** *Loose clothes, jewelry or long hair can be caught in moving parts.*
 - g. **Only use safety equipment that has been approved by an appropriate standards agency.** *Unapproved safety equipment may not provide adequate protection. Eye protection must be ANSI-approved and breathing protection must be NIOSH-approved for the specific hazards in the work area.*
- 4. **Power tool use and care**
 - a. **Do not force the power tool. Use the correct power tool for your application.** *The correct power tool will do the job better and safer at the rate for which it was designed.*
 - b. **Do not use the power tool if the Power Switch does not turn it on and off.** *Any power tool that cannot be controlled with the power switch is dangerous and must be repaired.*
 - c. **Disconnect the battery pack from the power tool before making any adjustments, changing accessories, or storing power tools.** *Such preventive safety measures reduce the risk of starting the power tool accidentally.*
 - 5. **Hold the power tool by insulated gripping surfaces when performing an operation where the cutting tool may contact hidden wiring.** *Contact with a "live" wire will make exposed metal parts of the tool "live" and shock the operator.*
 - 6. **Use clamps or another practical way to secure and support the work piece to a stable platform.** *Holding the work by hand or against your body leaves it unstable and may lead to loss of control.*
 - a. **Store idle power tools out of reach of children and do not allow persons unfamiliar with the power tool or these instructions to operate the power tool.** *Power tools are dangerous in the hands of untrained users.*
 - b. **Maintain power tools. Check for misalignment or binding of moving parts, breakage of parts and any other condition that may affect the power tool's operation. If damaged, have the power tool repaired before use.** *Many accidents are caused by poorly maintained power tools.*

c. **Keep cutting tools sharp and clean.**

Properly maintained cutting tools with sharp cutting edges are less likely to bind and are easier to control.

d. **Use the power tool and accessories in accordance with these instructions, taking into account the working conditions and the work to be performed.**

Use of the power tool for operations different from those intended could result in a hazardous situation.

7. **Battery tool use and care**

a. **Recharge only with the Charger specified by the manufacturer.**

A Charger that is suitable for one type of battery pack may create a risk of fire when used with another battery pack.

b. **Use power tools only with specifically designated battery packs.** *Use of any other battery packs may create a risk of injury and fire.*

c. **When battery pack is not in use, keep it away from other metal objects, like paper clips, coins, keys, nails, screws or other small metal objects, that can make a connection from one terminal to another.** *Shorting the battery terminals together may cause burns or a fire.*

d. **Under abusive conditions, liquid may be ejected from the battery; avoid contact. If contact accidentally occurs, flush with water. If liquid contacts eyes, additionally seek medical help.** *Liquid ejected from the battery may cause irritation or burns.*

8. **Service**

a. **Have your power tool serviced by a qualified repair person using only identical replacement parts.** *This will ensure that the safety of the power tool is maintained.*

Multifunction Tool Safety Warnings

1. Maintain labels and nameplates on the tool. These carry important safety information. If unreadable or missing, contact Harbor Freight Tools for a replacement.
2. Do not use this Multifunction Tool with any other Battery or Charger.
3. Avoid unintentional starting. Prepare to begin work before turning on the tool.
4. CAUTION: Avoid accidental injury. Keep hands and fingers safely away from the oscillating Scraper, Cutting Blade, and Sandpaper when operating the tool.
5. Avoid unintentional starting. Prepare to begin work before turning on the power tool.
6. Do not lay the tool down until it has come to a complete stop. Moving parts can grab the surface and pull the tool out of your control.
7. When using a handheld power tool, maintain a firm grip on the tool with both hands to resist starting torque.
8. Do not leave the tool unattended when the battery pack is installed. Turn off the tool, and remove the battery pack before leaving.



9. The battery pack and Charger get hot during use. The pack's heat can build up to unsafe levels and create a fire hazard if it does not receive adequate ventilation, due to an electrical fault, or if it is used in a hot environment. Do not place the Battery Pack on a flammable surface. Do not obstruct any vents on the Battery Pack. **Especially avoid placing the Battery Pack on carpets and rugs; they are not only**

flammable, but they also obstruct vents under the Battery Pack.

Place the Battery Pack on a stable, solid, nonflammable surface (such as a stable metal workbench or concrete floor) at least 1 foot away from all flammable objects, such as drapes or walls. Keep a fire extinguisher and a smoke detector in the area. Frequently monitor the Battery Pack and Charger while charging.

10. This product is not a toy. Keep it out of reach of children.
11. People with pacemakers should consult their physician(s) before use. Electromagnetic fields in close proximity to heart pacemaker could cause pacemaker interference or pacemaker failure. In addition, people with pacemakers should:
 - Avoid operating alone.
 - Do not use with power switch locked on.
 - Properly maintain and inspect to avoid electrical shock.
12. **WARNING:** Some dust created by power sanding, sawing, grinding, drilling, and other construction activities, contains chemicals known [to the State of California] to cause cancer, birth defects or other reproductive harm. Some examples of these chemicals are:
 - Lead from lead-based paints
 - Crystalline silica from bricks and cement or other masonry products
 - Arsenic and chromium from chemically treated lumberYour risk from these exposures varies, depending on how often you do this type of work. To reduce your exposure to these chemicals: work in a well ventilated area, and work with approved safety equipment, such as those dust masks that are specially designed to filter out

microscopic particles. (California Health & Safety Code § 25249.5, *et seq.*)

13. **WARNING:** Handling the Charger cord on this product will expose you to lead, a chemical known to the State of California to cause cancer, and birth defects or other reproductive harm. Wash hands after handling. (California Health & Safety Code § 25249.5, *et seq.*)
14. The warnings, precautions, and instructions discussed in this instruction manual cannot cover all possible conditions and situations that may occur. It must be understood by the operator that common sense and caution are factors which cannot be built into this product, but must be supplied by the operator.

Lithium Battery Safety Warnings



LITHIUM BATTERIES STORE A LARGE AMOUNT OF ENERGY AND WILL VENT FIRE OR EXPLODE IF MISTREATED:

1. **Keep Battery Pack dry.**
2. **DO NOT DO ANY OF THE FOLLOWING TO THE BATTERY PACK:**
 - a. **Open,**
 - b. **Drop,**
 - c. **Short-circuit,**
 - d. **Incinerate, or**
 - e. **Expose to temperatures greater than 140°F.**
3. Charge Battery Pack only according to the instructions in this manual.

4. Inspect Battery Pack before every use; do not use or charge if damaged.

abnormal vibration occurs, stop use immediately.

Vibration Safety

This tool vibrates during use. Repeated or long-term exposure to vibration may cause temporary or permanent physical injury, particularly to the hands, arms and shoulders. To reduce the risk of vibration-related injury:

1. Anyone using vibrating tools regularly or for an extended period should first be examined by a doctor and then have regular medical check-ups to ensure medical problems are not being caused or worsened from use. Pregnant women or people who have impaired blood circulation to the hand, past hand injuries, nervous system disorders, diabetes, or Raynaud's Disease should not use this tool. If you feel any symptoms related to vibration (such as tingling, numbness, and white or blue fingers), seek medical advice as soon as possible.
2. Do not smoke during use. Nicotine reduces the blood supply to the hands and fingers, increasing the risk of vibration-related injury.
3. Wear suitable gloves to reduce the vibration effects on the user.
4. Use tools with the lowest vibration when there is a choice.
5. Include vibration-free periods each day of work.
6. Grip tool as lightly as possible (while still keeping safe control of it). Let the tool do the work.
7. To reduce vibration, maintain the tool as explained in this manual. If any



SAVE THESE INSTRUCTIONS.

GROUNDING

⚠ WARNING

TO PREVENT ELECTRIC SHOCK

AND DEATH FROM INCORRECT GROUNDING WIRE CONNECTION:

Check with a qualified electrician if you are in doubt as to whether the outlet is properly grounded. Do not modify the Charger cord plug provided with the tool. Never remove the grounding prong from the plug. Do not use the tool if the power cord or plug is damaged. If damaged, have it repaired by a service facility before use. If the plug will not fit the outlet, have a proper outlet installed by a qualified electrician.



Double Insulated Tools: Tools with Two Prong Plugs

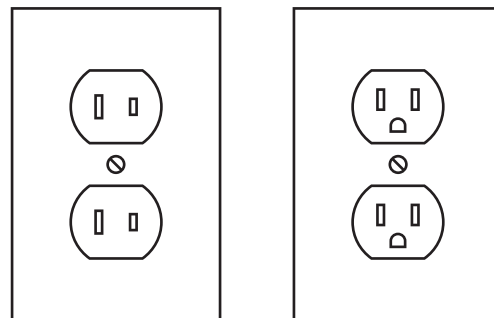

Outlets for 2-Prong Plug

1. Tools marked "Double Insulated" do not require grounding. They have a special double insulation system which satisfies OSHA requirements and complies with







the applicable standards of Underwriters Laboratories, Inc., the Canadian Standard Association, and the National Electrical Code.

2. Double insulated tools may be used in either of the 120 volt outlets shown in the preceding illustration. **(See Outlets for 2-Prong Plug.)**

Extension Cords

Note: Extension cords must not be used with this item's Charger.

Symbology

	Double Insulated
	Canadian Standards Association
	Underwriters Laboratories, Inc.
	Volts Alternating Current
	Amperes
	No Load Revolutions per Minute (RPM)

SPECIFICATIONS

Charger Input	120 VAC
Battery Type	12 V Lithium, 1.3 Ah
Motor Speed	15,000 OPM (No Load)
Accessories	Sandpaper (2 pieces for wood and 2 pieces for metal) Sanding Pad Cutting Blade Scraper Blade Hex Wrench

UNPACKING

When unpacking, make sure that the item is intact and undamaged. If any parts are missing or broken, please call Harbor Freight Tools at 1-800-444-3353 as soon as possible.

Accessory Attachments - This multi-purpose tool includes Sandpaper (504) and a Sanding Pad (503) for sanding wood or removing paint from surfaces, a Cutting Blade (502) to cut wood and soft metal such as copper piping, and a Scraper Blade (501) which can be used for scraping paint or wall paper from flat surfaces.

INSTRUCTIONS FOR PUTTING INTO USE



Read the **ENTIRE IMPORTANT SAFETY INFORMATION** section at the beginning of this manual including all text under subheadings therein before set up or use of this product.

WARNING

TO PREVENT SERIOUS INJURY

FROM ACCIDENTAL OPERATION:

Turn the Power Switch off and remove the Battery Pack before

assembling or making any adjustments to the tool.

Note: For additional information regarding the parts listed in the following pages, refer to the Assembly Diagram near the end of this manual.

Components



Figure 1

SET UP



Read the **ENTIRE IMPORTANT SAFETY INFORMATION** section at the beginning of this manual including all text under subheadings therein before set up or use of this product.

Work Piece and Work Area Set Up

1. Designate a work area that is clean and well-lit. The work area must not allow access by children or pets to prevent distraction and injury.
2. Route the power cord of the Charger along a safe route without creating a tripping hazard or exposing the power cord to possible damage.

Charging the Battery Pack

The Battery Pack needs to be charged before first use. It is recommended to recharge the Battery after every use.

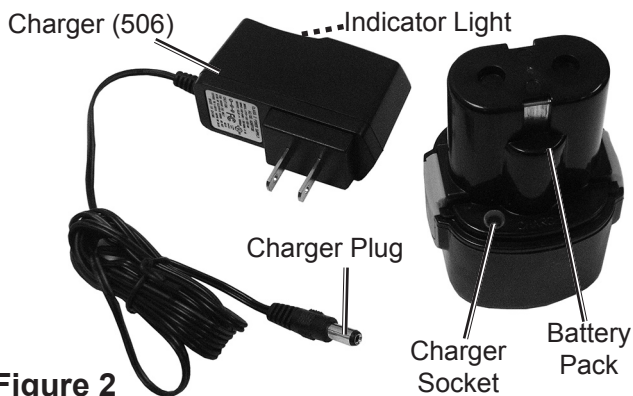

Figure 2

1. Place the Battery Pack on a dry fireproof surface in a room where the temperature ranges from 33-112° F.
2. Allow a recently exhausted Battery Pack to cool completely before charging. Make sure the Battery Pack is undamaged; do not charge a cracked or leaking pack.
3. Insert the Charger's plug into the Charger Socket on the Battery Pack, and plug the Charger into a grounded, 120V outlet. The indicator light on the Charger will turn red showing that the battery is charging.
4. When the indicator light turns green, the Battery Pack is fully charged. This process will take approximately 90 minutes.

5. Unplug the Battery Pack from the Charger and the Charger from the wall outlet.

Note: Do not use a battery pack immediately after charging. Allow it to cool first. Store the Charger and Battery Packs not in use indoors, away from children.

Installing Attachments

⚠WARNING TO PREVENT SERIOUS INJURY FROM ACCIDENTAL OPERATION:
Make sure the Battery Pack is removed from the Tool before installing accessories, or adjusting the tool.

1. To install an accessory:
 - a. Hold the Spindle (3) with a 13mm wrench (sold separately), and unthread the Cap Screw (1) using the Hex Wrench (505). Remove the Cap Screw and Retainer (2).

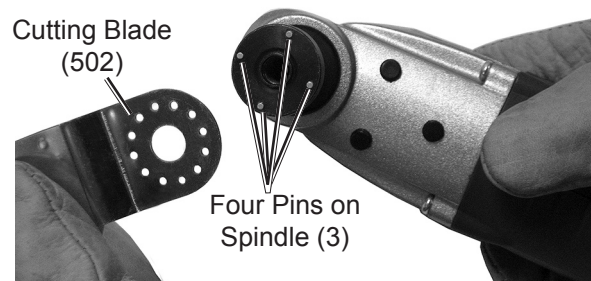

Figure 3

- b. Install the desired accessory in any one of seven forward orientations by aligning four of the holes in the accessory over the four pins on the Spindle.

CAUTION: Always face the accessory away from the handle to avoid injury.

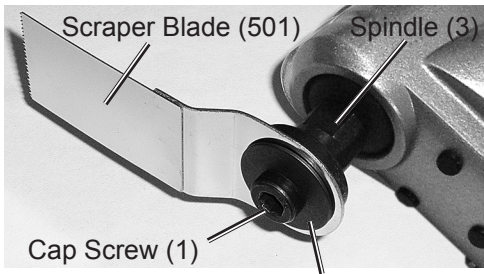

Figure 4 Retainer (2)

Note: When attaching the angled Cutting Blade (502) or Scraper Blade (501), orient the accessory as shown in Figure 4 above, so the Cap Screw (1) will be out of the way when working.

- c. Replace the Retainer and Cap Screw while holding the accessory. Hold the Spindle with the wrench, then tighten securely using the Hex Wrench.

CAUTION: Make sure that the accessory is held securely in place by the four pins on the Spindle as you tighten the Cap Screw.

Note: For sanding, first attach the Sanding Pad (503) to the tool, then align a sheet of Sandpaper (504) over the pad and press into place.

General Operating Instructions

1. Secure loose work pieces using a vise or clamps (not included) to prevent movement while working.
2. Install desired accessory.

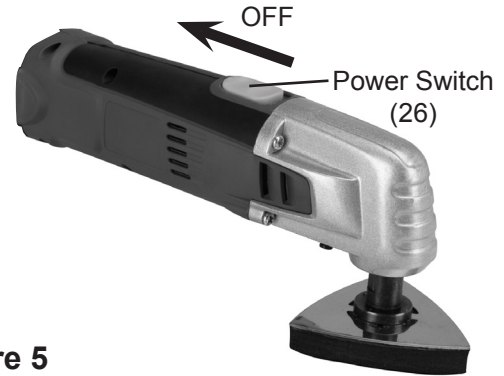

Figure 5

3. Make sure the Power Switch (26) is OFF.

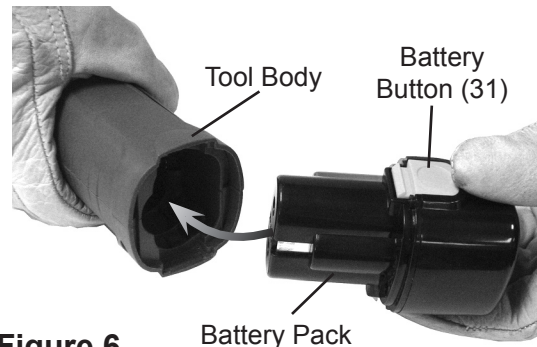

Figure 6

4. Once the Battery Pack is fully charged, slide it into the back of housing until it clicks into place.

Note: The Battery Pack fits into the Tool housing only one way. Match up the shape of the tool with the shape of the housing opening. The Battery Pack should slide easily into the housing. Do not force it into the Tool.

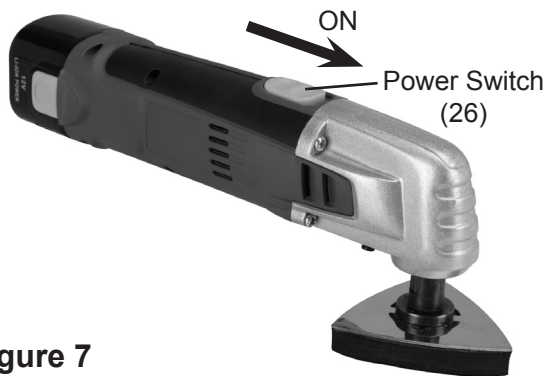

Figure 7

5. While holding the Tool with both hands, slide the Power Switch (26) forward to activate.
6. Do not allow contact between Sandpaper, Scraper, or Blade and workpiece until tool is at full speed.
7. Avoid contact with foreign objects such as metal screws and nails when sanding, scraping, or cutting.
8. Do not apply excessive pressure on the Tool. Allow the Tool to do the work.



Figure 8

9. When finished using, slide the Power Switch (26) OFF. Allow the tool to stop completely before setting it down.
10. Squeeze the Battery Buttons (31) on the side of the Battery Pack and slide the Battery Pack out of the Tool Body.
11. Remove the attachment and wipe clean.
12. Store the Tool and accessories in the Case (507), out of reach of children.

MAINTENANCE AND SERVICING

or Battery Pack. Keep Charger and Battery Pack dry.



Procedures not specifically explained in this manual must be performed only by a qualified technician.

⚠️ WARNING TO PREVENT SERIOUS INJURY

FROM ACCIDENTAL OPERATION:

Turn the Power Switch off and remove the Battery Pack from the tool before performing any inspection, maintenance, or cleaning procedures. Unplug the Charger before performing any inspection, maintenance or cleaning procedures.

TO PREVENT SERIOUS INJURY FROM TOOL FAILURE:

Do not use damaged equipment. If abnormal noise or vibration occurs, have the problem corrected before further use.

1. **BEFORE EACH USE**, inspect the general condition of the tool. Check for loose screws, misalignment or binding of moving parts, cracked or broken parts, damaged Charger electrical wiring, and any other condition that may affect its safe operation. Sandpaper should not be dull or contain excessive debris build-up. Scraper and Cutting Blade should be clean and sharp.
2. **AFTER USE**, wipe external surfaces of the tool with clean cloth.
3. **⚠️ WARNING!** Do not use if either the Battery Pack or Charger (506) are damaged in any way.
4. **Dispose of Battery Pack properly. Do not short, incinerate or open Charger**

Troubleshooting

Problem	Possible Causes	Likely Solutions
Tool will not start.	<ol style="list-style-type: none"> 1. Battery Pack needs charging 2. Battery Pack not properly seated. 3. Connection to Battery Pack damaged. 	<ol style="list-style-type: none"> 1. Charge Battery Pack. 2. Check that Battery Pack is fully inserted into tool so that it snaps into place. 3. Check that the terminals inside the tool are not bent or missing. Have repaired by a qualified technician if needed.
Tool operates slowly.	<ol style="list-style-type: none"> 1. Battery Pack needs charging. 2. Job is for a more powerful tool. 	<ol style="list-style-type: none"> 1. Charge Battery Pack. 2. Use a stronger powered tool.
Performance decreases over time.	<ol style="list-style-type: none"> 1. Accessory dull or damaged. 	<ol style="list-style-type: none"> 1. Keep cutting accessories sharp. Replace as needed. Replace sandpaper when it becomes worn or torn.
Excessive noise or rattling.	Internal damage or wear.	Have technician service tool.
Overheating.	<ol style="list-style-type: none"> 1. Forcing tool to work too fast. 2. Accessory misaligned. 3. Accessory dull or damaged. 4. Blocked motor housing vents. 	<ol style="list-style-type: none"> 1. Allow tool to work at its own rate. 2. Check and correct accessory to fence and/or table alignment. 3. Keep cutting accessories sharp. Replace as needed. Replace sandpaper when it becomes worn or torn. 4. Wear ANSI-approved safety goggles and NIOSH-approved dust mask/respirator while blowing dust out of motor using compressed air.



Follow all safety precautions whenever diagnosing or servicing the tool. Disconnect power supply before service.

PLEASE READ THE FOLLOWING CAREFULLY

THE MANUFACTURER AND/OR DISTRIBUTOR HAS PROVIDED THE PARTS LIST AND ASSEMBLY DIAGRAM IN THIS MANUAL AS A REFERENCE TOOL ONLY. NEITHER THE MANUFACTURER OR DISTRIBUTOR MAKES ANY REPRESENTATION OR WARRANTY OF ANY KIND TO THE BUYER THAT HE OR SHE IS QUALIFIED TO MAKE ANY REPAIRS TO THE PRODUCT, OR THAT HE OR SHE IS QUALIFIED TO REPLACE ANY PARTS OF THE PRODUCT. IN FACT, THE MANUFACTURER AND/OR DISTRIBUTOR EXPRESSLY STATES THAT ALL REPAIRS AND PARTS REPLACEMENTS SHOULD BE UNDERTAKEN BY CERTIFIED AND LICENSED TECHNICIANS, AND NOT BY THE BUYER. THE BUYER ASSUMES ALL RISK AND LIABILITY ARISING OUT OF HIS OR HER REPAIRS TO THE ORIGINAL PRODUCT OR REPLACEMENT PARTS THERETO, OR ARISING OUT OF HIS OR HER INSTALLATION OF REPLACEMENT PARTS THERETO.

PARTS LIST & ASSEMBLY DIAGRAM

Part	Description	Qty
1	Cap Screw M8 x 12	1
2	Retainer	1
3	Spindle	1
4	Rubber Casing	1
5	Circlip for shaft 26	1
6	Spring Washer	1
7	Bearing 6000	1
8	Block	1
9	Bushing	1
10	Screw ST4 x 20	4
11	Reducer	1
12	Circlip for Shaft 4	1
13	Bearing 625	1
14	Shaft	1
15	Bearing 608	1
16	Screw M3 x 18	2
17	Seal Packing Collar	2
18	Middle Cover	1
19	Seal Packing Collar	2
20	Motor	1
21	Trigger	1
22	Spring	1
23	Right Housing	1

Part	Description	Qty
24	Left Housing	1
26	Power Switch	1
27	Screw ST3.2 x 14	2
28	Electrical Contact	1
29	Screw ST3.2 x 14	4
30	Battery Cover (Front)	1
31	Battery Button	2
32	Button Spring	2
33	Pole End Plate	1
34	Battery (Li-ion) 12V	1
35	Protection Board	1
36	Charging Port	1
37	Screw ST2 x 8	4
38	Charging Indicator	1
39	Battery Cover (End)	1
41	Screw ST3.2 x 14	3
501	Scraper Blade	1
502	Cutting Blade	1
503	Sanding Pad	1
504	Sandpaper	4
505	Hex Wrench	1
506	Charger	1
507	Case (not shown)	1

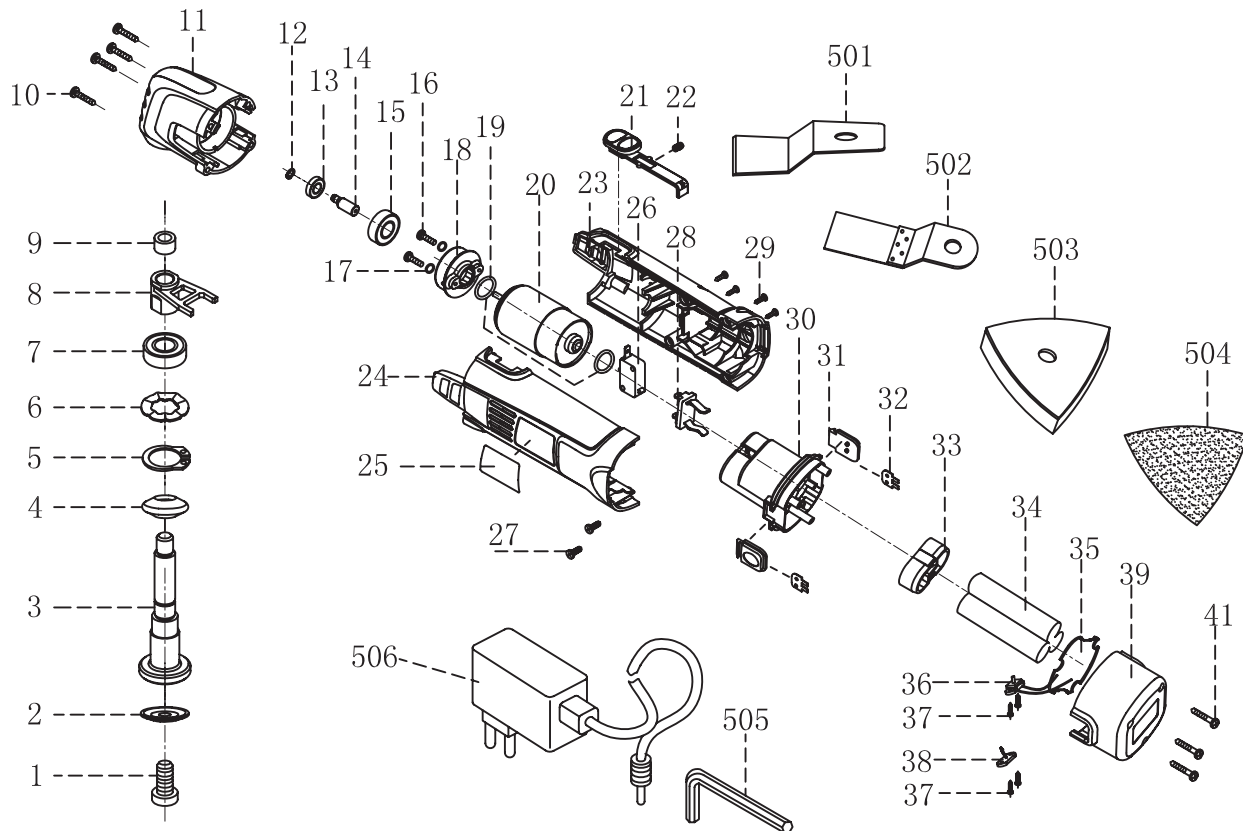

LIMITED 90 DAY WARRANTY

Harbor Freight Tools Co. makes every effort to assure that its products meet high quality and durability standards, and warrants to the original purchaser that this product is free from defects in materials and workmanship for the period of 90 days from the date of purchase. This warranty does not apply to damage due directly or indirectly, to misuse, abuse, negligence or accidents, repairs or alterations outside our facilities, criminal activity, improper installation, normal wear and tear, or to lack of maintenance. We shall in no event be liable for death, injuries to persons or property, or for incidental, contingent, special or consequential damages arising from the use of our product. Some states do not allow the exclusion or limitation of incidental or consequential damages, so the above limitation of exclusion may not apply to you. THIS WARRANTY IS EXPRESSLY IN LIEU OF ALL OTHER WARRANTIES, EXPRESS OR IMPLIED, INCLUDING THE WARRANTIES OF MERCHANTABILITY AND FITNESS.

To take advantage of this warranty, the product or part must be returned to us with transportation charges prepaid. Proof of purchase date and an explanation of the complaint must accompany the merchandise. If our inspection verifies the defect, we will either repair or replace the product at our election or we may elect to refund the purchase price if we cannot readily and quickly provide you with a replacement. We will return repaired products at our expense, but if we determine there is no defect, or that the defect resulted from causes not within the scope of our warranty, then you must bear the cost of returning the product.

This warranty gives you specific legal rights and you may also have other rights which vary from state to state.

3491 Mission Oaks Blvd. • PO Box 6009 • Camarillo, CA 93011 • (800) 444-3353

Record Product's Serial Number Here: _____

Note: If product has no serial number, record month and year of purchase instead.

Note: Some parts are listed and shown for illustration purposes only, and are not available individually as replacement parts.